

WaterTECH

Whirlpool and Air Baths

RECEIVING & INSTALLATION INFORMATION

WHAT TO DO WHEN YOU RECEIVE YOUR NEW WATERTECH TUB

IT IS YOUR RESPONSIBILITY TO INSPECT THE TUB: Notices are placed on and in the tub and shipping carton advising of this responsibility. The tub owner or installer is responsible to ensure the unit is free of defects and damage. In the event a problem exists, the unit **must not** be installed. Watertech is not responsible for defects or damage that could have been discovered, repaired, or avoided by inspection and testing prior to installation. The tub must be checked thoroughly upon delivery.

INSPECTION AND CLAIMS PROCEDURE: Follow the steps below to eliminate any questions about who is responsible for visible or concealed damage that may have occurred in shipping. Examine the shipping box for signs of damage or mishandling, i.e. staples pulled loose, flaps unglued, punches to the box, severe indentations, or crushed corners. If the box is damaged, the delivery person and receiving person / consignee must note the damage to the box on delivery paperwork before opening the box. Open the box and inspect the tub for damage. If damage is found, call Watertech at 1-800-289-8827 before accepting tub. Minor defects such as scuffs, scratches, etc... can be easily taken care of by one of our service people. All issues need to be resolved before signing delivery paperwork.

CONCEALED DAMAGE: Watertech allows the consignee / owner no more than 48 hours from time of receipt to inspect and report any concealed damage (i.e. leaks, broken pipes, etc...) or shortages of merchandise ordered (i.e. heater, drain, jet trim, etc...). Report concealed damage and shortage to Watertech 1-800-289-8827.

FAILURE OF THE CONSIGNEE TO INSPECT AND REPORT ANY CONCEALED DAMAGE WITHIN THE 48 HOUR PERIOD PLACES FULL RESPONSIBILITY FOR ANY CONCEALED DAMAGE ON THE CONSIGNEE.

PRE-TEST YOUR TUB: You must pretest your tub for leaks within 48 hours of receipt. Watertech tubs go through rigorous testing for plumbing leaks and proper operation prior to shipping, but as a secondary precaution, the tub must be re-tested for leaks and proper operation within the allotted 48 hours and before installation. Test your tub in a location that will not be damaged by spilled water such as a basement, driveway, or a garage. Pre-testing your tub allows you to find any plumbing connections that might have worked loose during shipping.

HOW TO PRE-TEST YOUR TUB: Place your tub on a firm flat surface and tape over the drain. Fill with water to 1 or 2 inches above the highest jet. Plug the motor into a GFCI protected outlet, and with the pump running, check all pipes and fittings for moisture. If no leaks are found, you may continue the Installation process.

IF ANY PROBLEMS ARE DISCOVERED DO NOT INSTALL THE TUB UNTIL YOU HAVE SPOKEN WITH A WATERTECH REPRESENTATIVE AT 1-800-289-8827

WATERTECH IS NOT RESPONSIBLE FOR DAMAGE THAT COULD HAVE BEEN DISCOVERED, REPAIRED, OR AVOIDED BY INSPECTING & TESTING PRIOR TO INSTALLATION.

INSTALLATION INSTRUCTIONS

WATERTECH RECOMMENDS THAT MOUNTING CABINET AND FINISHED MATERIALS **NOT BE CONSTRUCTED** AND INSTALLED PRIOR TO RECEIVING YOUR TUB.

STEP ONE

Place the tub on a flat level surface and measure from the bottom of the tub lip to the floor at locations indicated in the drawing below.

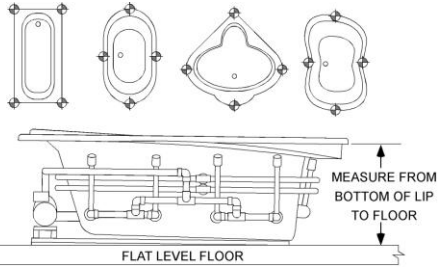

OWNER/INSTALLER BEARS FULL RESPONSIBILITY TO MAKE SURE THE BATH WILL FIT THE CABINET CONSTRUCTED FOR THE TUB AND ALL INSTALLATION INSTRUCTIONS ARE FOLLOWED.

STEP TWO

Add ½" to the largest measurement.

STEP THREE

Construct the cabinet the tub will sit in using the dimension from step two. The cabinet top must be level in all directions and the cabinet depth be measured from the top of the finish material (tile, stone, Corian, etc.) to the floor.

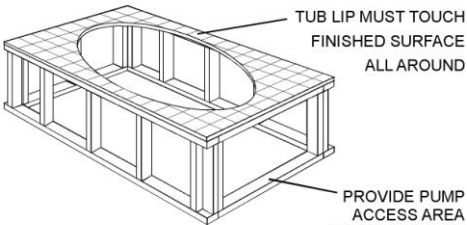

TYPICAL CABINET CONSTRUCTION

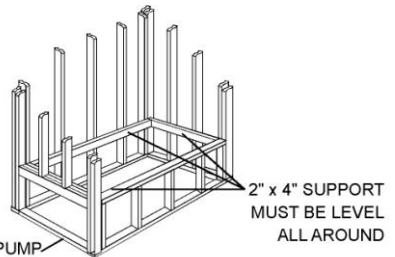

ALTERNATIVE CABINET CONSTRUCTION

STEP FOUR

Place tub in cabinet, check for fit, and make final adjustments.

MAKE SURE THE TUB WILL FIT IN THE ROUGH OPENING BEFORE INSTALLING THE FINISHING MATERIALS.

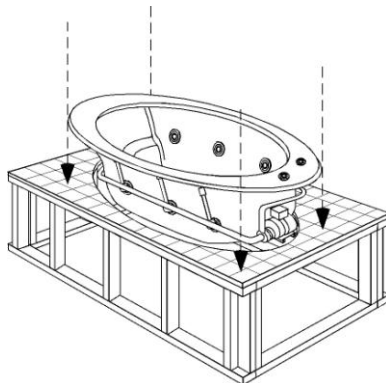

STEP FIVE

Look under your tub. The rails should be approximately 1/2" off the floor. The space between the tub bottom and floor must be completely filled with mortar and the mortar covered with plastic sheet in step six.

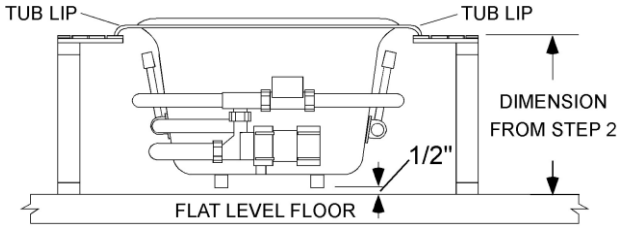

STEP SIX

Take the tub out of the cabinet and place enough mortar onto the floor in the area under the bottom of the tub to completely fill the space you saw in step five. This is usually 2" to 4". Cover mortar with 3 to 5 mil plastic sheet to allow the tub to be removed in the future.

NOTE:

The tub's weight (including bather and water) must be fully supported by the mortar under the tub's bottom - not the tub lip that rests on cabinet tile.

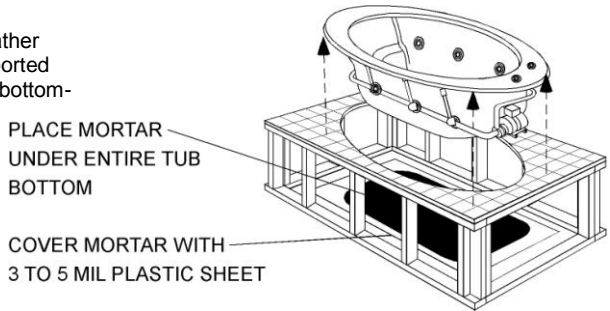

STEP SEVEN

Place the tub back in cabinet and push downward until tub lip rests evenly on top of cabinet. Area between the tub bottom and the floor is filled completely, and the mortar squishes out around the tub's bottom.

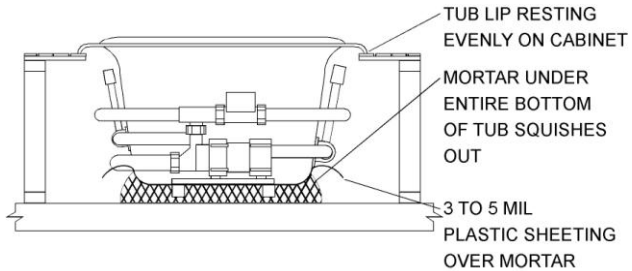

WARNING!

DO NOT GET INTO TUB FOR ANY REASON UNTIL MORTAR BED HAS CURED COMPLETELY AS YOUR TUB COULD BE DAMAGED AND VOID OUR WARRANTY.

QUESTIONS?

PLEASE CALL: 1-800-289-8827 FOR ASISTANCE

DRAIN CONNECTIONS

Follow all industry standard plumbing procedures for installation of overflow and drain. Care must be taken to insure watertight connections. The diagrams below are typical drain installations for Watertech Whirlpool Baths. For best results follow the instructions provided by the manufacturer of your drain

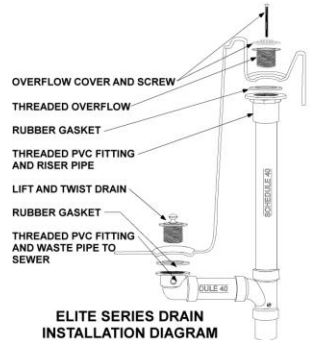
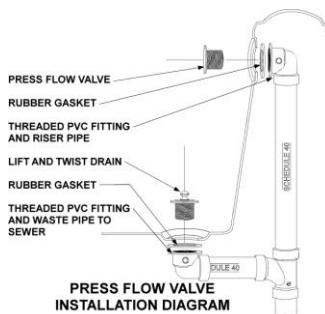
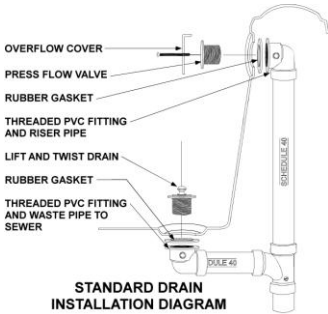

TILE FLANGE

The tile flange is an aluminum angle designed to allow a watertight seal between the tub surround and the tub. The tile flange is typically positioned behind the tile backer board and is attached to the tub surface with the high tack foam tape provided as part of the flange. Tile or other waterproof material is usually installed over the backer board and flange and finished with a caulk joint at the tub.

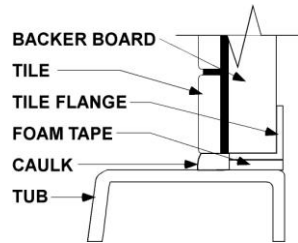

WHIRLPOOL PUMP

ELECTRICAL REQUIREMENTS:

120 VOLT AC
20 AMP DEDICATED CIRCUIT
GFCI OUTLET

ALL BRANCH CIRCUITS TO THE WHIRLPOOL, AND ALL ELECTRICAL COMPONENTS MUST BE GROUNDED.

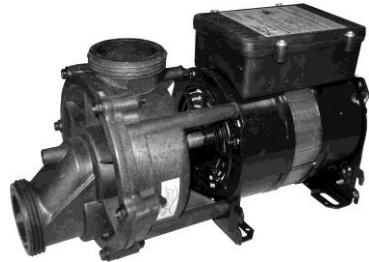

ALL ELECTRICAL CONNECTIONS TO YOUR TUB MUST BE MADE BY A QUALIFIED ELECTRICIAN IN ACCORDANCE WITH THE NATIONAL ELECTRICAL CODE AND ANY LOCAL CODES.

Should your pump ever need servicing, you can easily remove it from the tub by unscrewing the quick disconnect unions at the top and front of the pump housing and remove the pump mounting screws. After servicing it can be returned to service by reversing the procedure.

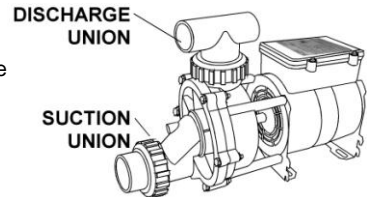

Thoroughly check for leaks after reinstallation.

OPERATING YOUR NEW WHIRLPOOL

Before you turn your whirlpool on it should be filled with water two inches above the highest jet. To turn the whirlpool on press the round ON/OFF button installed on your tub. To turn the bath off press the button again. If the pump does not start, either the GFCI is tripped, there is no electrical power, or the tube to the motor is disconnected at the air switch or motor.

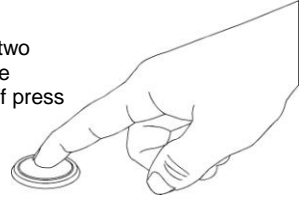

For tubs that do not come with installed buttons and controls, the installer must mount all controls above water level on a nearby surface.

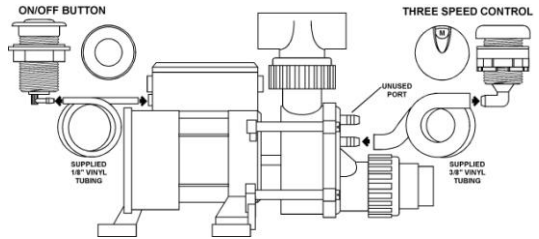

THREE SPEED CONTROL

The three speed control button allows the bather to simultaneously switch all jets from high to medium to low instead of individually adjusting each jet's pressure.

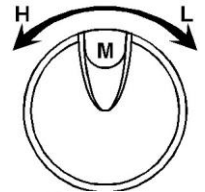

ADJUSTING YOUR TUB'S JETS

Your Watertech Whirlpool Bath comes equipped with high performance spa jets that allow the bather complete control of water pressure and direction. Rotating the jet's circular face to the right increases the water pressure and volume or to the left reduces the pressure and volume. The direction of the water flow may be changed by moving the jet eyeball up, down, left, or right to direct the water to the desired location.

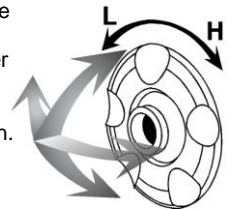

JET CLEANING OR SERVICING

Each jet face is easily removed from the inside of the tub for service or cleaning. The jet face and the pulsating face may be removed by carefully prying away from the tub with a thin spatula or putty knife. Care should be taken not to scratch the tub or jet. To avoid causing leaks do not disturb the inner retainer.

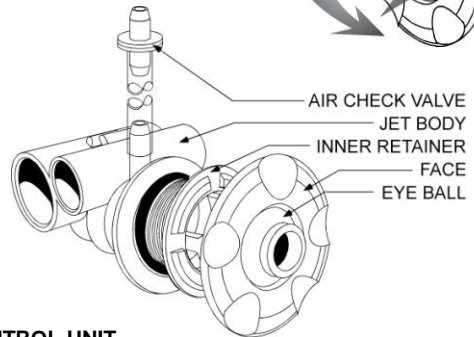

OPTIONAL LOW WATER SENSOR CONTROL UNIT

The optional factory installed low water sensor protects your whirlpool from running if there is not enough water to operate safely. Should your whirlpool fail to operate when filled to the proper depth be sure there is electrical power available at the outlet. If power is available adjust the sensor by filling your tub to the proper depth. Locate the sensor under your tub and slowly turn the sensor adjustment screw until the indicator light turns on. Back the screw slowly until the light goes off. Very slowly turn the screw until the light *just* comes on again. Drain the tub water below the water level sensor. The light should

INDICATOR LIGHT
ADJUSTMENT SCREW

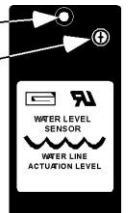

turn off. Refill to be sure the light comes on again. Repeat this process until the sensor activates and deactivates at the desired level.
If your whirlpool still fails to run contact Watertech technical support at **1-800-289-8827**.

OPTIONAL VARIABLE FLOW CONTROL

Electronic Variable flow controls allow the bather to select the desired jet pressure. To operate push the electronic control button's jet symbol to start the pump. By pushing the + or – the pump speed and jet's pressure are increased or decreased. Pressing the + or – symbols simultaneously places the system in pulsation mode. To exit pulsation mode press either the + or – symbol. To turn off the system press the jet symbol twice. The last speed selected is in the system's memory for the next use.

Tubs with the optional Electronic Variable Flow Control may have a small metal sensor located in the tub at the operational water level.

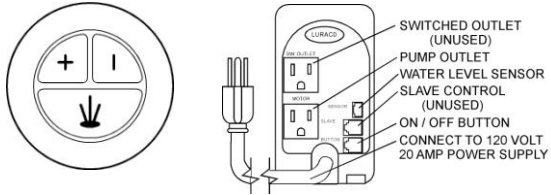

OPTIONAL ELECTRIC IN LINE HEATER 120 volt 13.5 amp

Your whirlpool may be equipped with an electric heater to maintain the water temperature lost through evaporation and convection loss. The electric in-line heater will maintain the bath's initial water temperature and cycles with the pump.

ELECTRICAL REQUIREMENTS:

120 VOLT AC
20 AMP DEDICATED CIRCUIT
GFCI OUTLET

ALL WHIRLPOOL BRANCH CIRCUITS AND COMPONENTS MUST BE GROUNDED



TYPICAL HEATER CONFIGURATIONS

OPERATION

The totally automatic heater will activate to maintain the temperature of the water when the whirlpool pump is running.

HIGH LIMIT

The heater's high-limit safety device will trip if the temperature exceeds a safe preset temperature. If the high-limit trips, the heater will be disabled until the power has been removed from the heater and it has cooled. The high-limit switch will automatically reset. This is most easily accomplished by turning off the circuit breaker under the tub. Should the high-limit trip repeatedly, do not use the tub until the heater has been serviced.

OPTIONAL MOOD LIGHTS STANDARD OR LED

Optional factory installed mood lights are powered by a 120v/12v transformer attached to the outside of your whirlpool. Illumination is provided by an incandescent lamp or an LED lamp mounted behind a clear lens body. To change the bulb unscrew the central portion of the lens with the supplied tools and carefully pull the lamp out. Take care not to disturb the outer portion of the lens to prevent leaks.



Replace the lamp only with an identical bulb.

ELECTRICAL REQUIREMENTS:

120 VOLT
CLASS A GFCI OUTLET

STANDARD MOOD LIGHT OPERATION

To turn the mood light on press the round on/off button installed on your tub. To turn the mood light off press the button again.

To change the color of your mood light snap one of the colored filters over the clear lens.

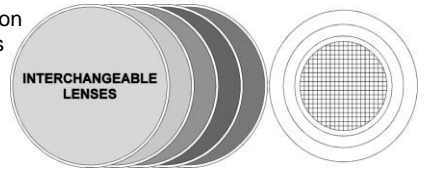

LED MOOD LIGHT OPERATION

Pressing the LED button installed on your tub activates the LED lamp. Repeated pressing of the LED button changes the color of the lamp in sequence until all the colors have been lit. Pressing the LED button again causes the mood light to change colors in sequence until the LED button is pressed again turning the LED mood light off.

OPTIONAL GRAB HANDLES

Grab handles are not designed to be mounted on the tub. Mount your grab handles onto the tub cabinet or a surrounding wall. Attach the handles with the supplied screws. Mounting to drywall may require structural reinforcement.



OPTIONAL PRESS FLOW DRAIN AND OVERFLOW

The Press Flow drain and overflow allow the bather to fill the tub above the normal water level. Closing the Press Flow overflow will allow the tub to be filled to the top.

The bather is responsible for making sure the tub does not overflow and should not close the overflow until fully in the tub.

Watertech Whirlpool Baths assume no responsibility for damage caused by improper use of the Press Flow overflow.

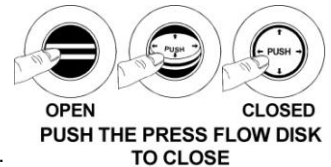

OPTIONAL TURBO CHARGING SYSTEM

The turbo charging system is composed of a single speed, 1 H.P., 675 watt heated blower, and installation components.

Connect your blower to the manifold as shown using the ribbed air hose and clamps. Blower is shipped separately for custom placement. Locate the blower in a convenient space of your choice.



IMPORTANT SAFETY INSTRUCTIONS

- RISK OF ELECTRICAL SHOCK! DO NOT PERMIT ANY ELECTRICAL APPLIANCES (RADIO, LIGHT, TELEPHONE, OR TELEVISION) WITHIN FIVE FEET OF THE WHIRLPOOL BATH TUB.**
- DO NOT REMOVE THE SUCTION COVERS FROM YOUR WHIRLPOOL TUB.**
- TO REDUCE THE RISK OF INJURY:**
 - Water in your whirlpool should not exceed 104 degrees F. Lower Temperatures are advised for extended use and definitely for younger children.
 - Pregnant or possibly pregnant women should consult their Physician before using the whirlpool. Water temperatures above 100 degrees not recommended.
 - Use of alcohol, drugs, or medications before or during use of the whirlpool may lead to unconsciousness and possible drowning. Consult your physician about your medications before using the whirlpool.
 - Persons suffering from obesity or with a history of heart disease, circulatory problems, or diabetes should consult a physician before using the whirlpool.
- WARNING! RISK OF CHILD DROWNING!!** To reduce the risk of child drowning, do not permit children to use the whirlpool unless closely supervised.

WATERTECH WHIRLPOOL BATHS LIMITED LIFETIME WARRANTY WARRANTY COVERAGE

Watertech Whirlpool Bath (the "Company") offers the following expressed limited lifetime warranty to the original purchaser of any Watertech Whirlpool Bath who purchases the Bath for personal or single family residential use ("user"): The Company will repair or replace, at the sole option, the Bath or its equipment in accordance with the following terms and conditions.

LIFETIME WARRANTY ON BATHS

The Company extends to the original purchaser of the Bath a non-transferable limited warranty that the shell will maintain its structural integrity and configuration and be free of water loss due to a defect in the tub shell. The warranty covers only the tub shell and the manufacturer installed pump. Our limited warranty on options and accessories is for one year. Warranty coverage begins on the date the option or accessory was originally purchased by the user.

WARRANTY LIMITATIONS

Our limited warranty does not cover defects, damage, or failure caused by the common carrier, installer, user, or other persons, pets, or rodent, or resulting from, without limitation, any of the following: careless handling (lifting unit by plumbing, abrading finish, etc) including its own negligence; modification of any type for any reason (including specifications provided with the unit); connections supplied by the installer of the equipment; improper voltage supply or unit without specified minimum amount of water or at inappropriate water temperature; use of abrasive or improper cleaners; or acts of God, such as lightning, floods, earthquakes, etc. In addition, **THE COMPANY WILL NOT BE RESPONSIBLE FOR INCIDENTAL, OR CONSEQUENTIAL DAMAGES** or losses arising from the cause (e.g. water damage to carpet, ceiling, tiles, marble, loss of use, etc). This limited warranty does not include: labor, transportation, or other costs incurred in the removal and/or installation of the original unit and/or installation of a replacement (unit; any costs relating to obtaining access for repair; or loss of use damage, including loss of sales, profit or business advantage of any kind under any circumstances. Warranty coverage is provided in the United States of America.

RESPONSIBILITIES OF OTHERS

Inspecting the unit prior to installation is the responsibility of the installer or building contractor who acts on behalf of the user. They are responsible for ensuring the unit is free of defect or damage. Notices are placed on and in the unit and on the shipping carton advising the installer of this responsibility. In the event of a problem, the unit must not be installed.

The Company is not responsible for failures or damage that could have been discovered, repaired, or avoided by proper inspection and testing (including proper water testing) prior to installation and before final enclosure failure to do so voids warranty.

Damage occurring in transit is the responsibility of the carrier, delivery person, or seller of the product. The buyer or those acting on their behalf must inspect the bath for damage and shortages before signing any receiving documents. The receiving person must note any damage to the shipping box (i.e. punctures, indentations, crushed areas, etc...) on the receiving documents. The shipping box should then be opened and the receiving person and delivery person must visually inspect the bath for damage and note on the receiving documents any damage or shortages of merchandise. If damage or shortages are found, call Watertech Whirlpool Bath at 1-800-289-8827 to discuss the issues found before signing the receiving documents. Minor issues can be easily addressed by one of our field representatives. All issues, problems, and concerns need to be resolved before signing any receiving documents. Watertech allows buyer or those acting on his behalf an additional 48 hours after signing receiving documents to re-inspect, note any shortages, and inspect and water test the bath for leaks and damages that were concealed or overlooked during the initial inspection. It is the buyer's responsibility to report any damage or shortages during the 48 hour period.

Phone 1-800-289-8827 Fax 1-423-926-438

Information should be reported to both seller and Watertech

It is the responsibility of the installer, building contractor, or user to provide access for service. The Company is not responsible for any costs relating to obtaining access for repair. The user shall bear such costs and, if appropriate, must seek recovery from the installer.

Damage occurring to the unit during installation is the responsibility of the installer and/or building contractor and damage occurring thereafter is the responsibility of the user. For the customer's benefit, the Company maintains a list of independent service personnel to perform required warranty service repairs. Such firms are not agents or representatives of the Company and cannot bind the Company by words or conduct.

**WATERTECH WHIRLPOOL BATH
2507 Plymouth Road
Johnson City, Tennessee 37601**

